

Wechsler
 Changeover contact
 Contact inverseur

5A / 250V a.c.
 4A / 30V d.c.

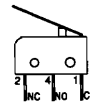

Flachstecker DIN 46244-A 2,8x0,5
 Taps
 Fiche plate

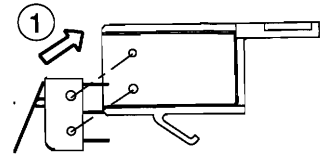
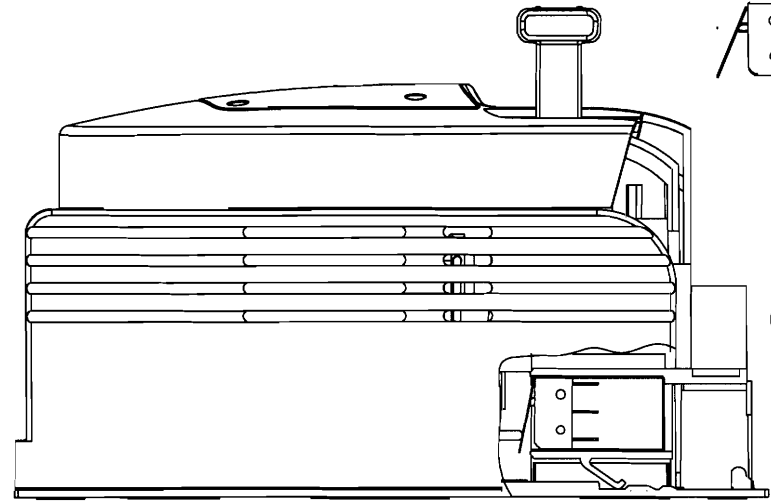
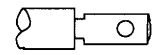

Operation Position

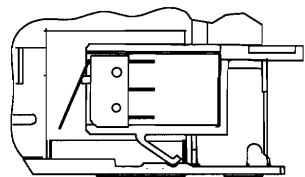
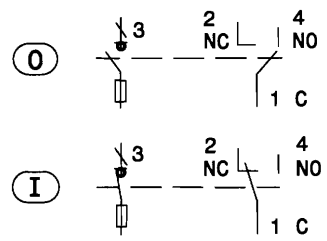
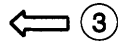

Test Position